

30W 700mA In-Door Settable Current LED Driver (compact type)

Product Offering

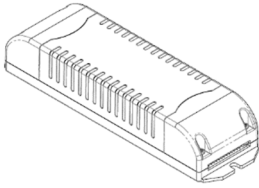

Order part number:
SCA-AD-030W-0A70-A-PV-20-C

Product Description:

- Output current selectable by Dip-Switch with 9 levels selection and flickering free
- Standby power $\leq 0.5W$ ⁽¹⁾
- AUX 12V output for drive other control module
- Dimming interface: 0-10V/1-10V; PWM ⁽²⁾
- Nominal life 50,000hrs (at tc 65 °C with a failure rate <0.2% per 1,000hrs)

Feature:

- High efficiency with PF>0.95 and low THD <15% (typ.10%)
- Flickering free
- 0-10V/1-10V or PWM dimming interface ⁽²⁾
- Fully protected: Short circuit, input voltage surge, overvoltage protection, over-temperature protection

Technical Data

Rated supply voltage, AC	220-240 Vac, 50/60Hz
AC Voltage range, AC	90-267 Vac, 50/60Hz
Survive input range (for 30mins)	265-305 Vac, 50/60Hz
DC Voltage Range, DC	176-276V
Rated current @230Vac (with AUX)	<0.33A
Leakage current @240Vac	<0.5mA@240Vac
Max. input power (with AUX)	40W
Typ. efficiency (at 230V 50Hz, full load)	Typ. 88%
Inrush current (at cold start, full load @230V)	<20A (T-width <100µs)
Typ. λ (at 230 V 50Hz, Full load)	>0.95
Typ. λ (at 230 V 50Hz, Min. load)	>0.7
Turn on time (at 230V 50Hz, full load)	<0.5s (without dimming signal)
Output rated power	30.8W@700mA, 44Vdc
Output current (selectable; $\pm 5\%$)	100...700mA (refer to current selection table)
Output Voltage (dc)	20-44V
Output ripple current (100Hz)	< 5% (typ.)
DC AUX output	12V (1.5W max)
Dimming interface	0-10V/1-10V; PWM (10V@100-3kHz)
Dimming level range	0%, 10-100%
Surge Voltage	light industry level (surge 2KV)
Ambient temperature ta	-15 ... +50 °C
Max. Casing temperature tc	80 °C
Size (mm)	175x49.5x31
Weight	180g

Output Current Selection Table

Output current selector

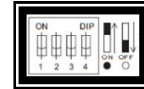

Current selection (9 levels)

Output current ($\pm 5\%$)	Output Voltage range (Vdc)		Output Current Selector			
			1	2	3	4
700mA	20	44	○	○	○	●
600mA	20	44	○	○	●	○
500mA	20	44	○	○	●	●
400mA	20	44	○	●	○	○
350mA	20	44	○	●	○	●
300mA	20	44	○	○	●	○
250mA	20	44	○	●	●	●
180mA	20	44	●	○	○	●
100mA	20	44	●	●	●	●

Standard comply

EN55015; EN61000-3-2; EN61000-3-3; EN61547;
EN61347-1; EN61347-2-13; SELV

Remark:

- (1) Not included the AUX 12V output power.
(2) Please ask sale department in detail if use PWM signal dimming.
(3) The specification is subject to change without notes.

30W 700mA In-Door Settable Current LED Driver (compact type)

Operation Output Diagram:

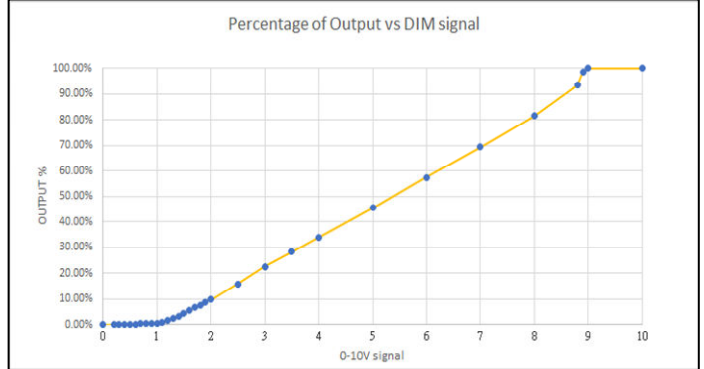
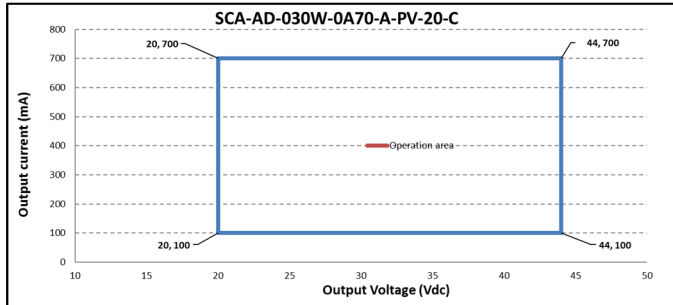

The above curve is for reference only and not represent the actual value.

Dimming cable diagram:

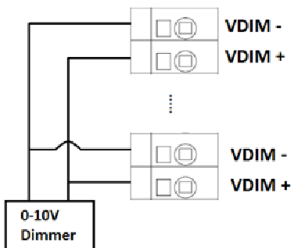

Dimming Interface: 0-10V/1-10V/PWM

Dimension and product label:

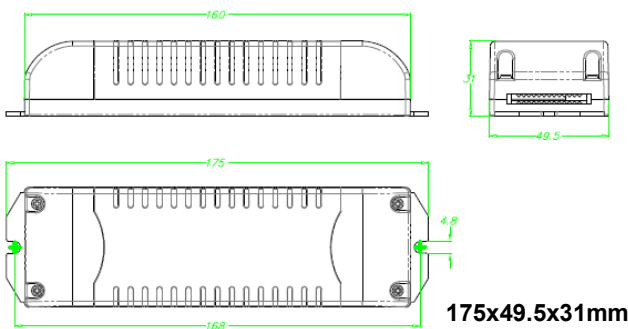
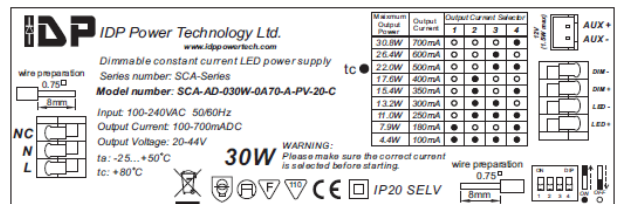
IDP Power Technology Ltd.
www.idppowertech.com

Dimmable constant current LED power supply
Series number: SCA-Series
Model number: SCA-AD-030W-0A70-A-PV-20-C

Input: 100-240VAC 50/60Hz
Output Voltage: 20-44V
Output Current: 100-700mAADC
ts: -25...+50°C
tc: +80°C

Maximum Output Power	Output Current	Output Current Selection			
		1	2	3	4
30.0W	700mA	○	○	○	●
24.0W	600mA	○	○	○	○
22.0W	500mA	○	○	○	○
17.0W	400mA	○	○	○	○
15.0W	300mA	○	○	○	○
13.0W	300mA	○	○	○	○
11.0W	250mA	○	○	○	○
7.9W	180mA	○	○	○	○
4.4W	100mA	○	○	○	○

Input: NC, N, L
Output: AUX+, AUX-
Output: 0W, 20W, 4.0W

WARNING: Please make sure the correct current is selected before starting.

IP20 SELV

Remark:

- (1) Not included the AUX 12V output power.
- (2) Please ask sale department in detail if use PWM signal dimming.
- (3) The specification is subject to change without notes.