

# LED LIGHTING

## CATALOGUE

VER. 01

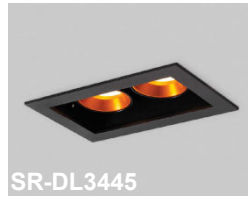
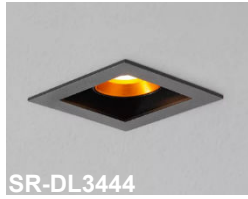

## DOWNLIGHTS

**SQUARE** series is a range of product which has traditional box type design. These products are widely used in commercial and hospitality area.

**Litesyn**  
Your Luminaire craftsman

## SQUARE/SPOT LIGHT/MINI/BOX/SINGLE/TILTABLE

**Model: SR-DL3444**

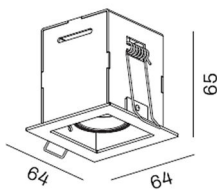

 Cutout: 55x55mm

 5-25mm

### Feature:

- Single head square grilled downlight
- Interchangeable baffle
- Compact design

### Technical data:

- Light source COB or others
- LED Power (max) 5.4W (150mA, 36V)
- System Power (ref.) 7W (ref. only depends on the ECG)
- Lumen flux (typ.) 350lm
- Colour temperature 2700K, 3000K, 4000K
- Colour rendering index Ra $\geq$ 90
- MacAdam Step 3
- Beam Angle 15D, 24D, 36D PMMA Lens
- Tilttable Yes
- Ingress protection IP21
- Operation temperature 0-40C
- Protection Class III
- LED Life time 50,000h L70B10
- Finishing White/Black
- Baffle Finishing Plain White/Plain Black/Brushed Brass
- Construction Aluminum
- Installation Ceiling Recessed, spring type
- Dimension 64x64mmx65mm(H)/Cutout 55x55mm
- LED Driver Remote
- Trimless version No

### Electronic control gear

NON-DIM/Dimmable

 MP series

1-10V/0-10V/DALI

 SC series

Other brand is available upon request

\*Use IDP multi-power LED Driver can trim down the output power according to actual application.

### Light Distribution For 3000K

spot 24°

medium 36°

h(m)	E(lx)	ø(m)	h(m)	E(lx)	ø(m)
1	1021	ø0.18	1	587.2	ø0.25
2	255.4	ø0.36	2	146.84	ø0.51
3	113.52	ø0.54	3	65.28	ø0.76
4	63.84	ø0.72	4	36.72	ø1.02
5	40.88	ø0.91	5	23.48	ø1.27

**\*\*Accessories (optional): Honeycomb louvre**

**\*\*The specification is subject to change without note.\*\***

## SQUARE/SPOT LIGHT/ MINI/BOX/TWIN HEADS/TILTABLE

**Model: SR-DL3445**



### Feature:

- TWIN heads square grilled downlight
- Interchangeable baffle
- Compact design

### Technical data:

▪ Light source	COB or others
▪ LED Power (max)	5.4W x 2 (150mA x 2 , 36V)
▪ System Power (ref.)	7W x 2 (ref. only depends on the ECG)
▪ Lumen flux (typ.)	350lm x 2
▪ Colour temperature	2700K, 3000K, 4000K
▪ Colour rendering index	Ra≥90
▪ MacAdam Step	3
▪ Beam Angle	15D, 24D, 36D PMMA Lens
▪ Tilttable	Yes
▪ Ingress protection	IP21
▪ Operation temperature	0-40C
▪ Protection Class	III
▪ LED Life time	50,000h L70B10
▪ Finishing	White/Black
▪ Baffle Finishing	Plain White/Plain Black/Brushed Brass
▪ Construction	Aluminum
▪ Installation	Ceiling Recessed, spring type
▪ Dimension	103x64mmx65mm(H)/Cutout 94x55mm
▪ LED Driver	Remote
▪ Trimless version	No

### Electronic control gear

NON-DIM/Dimmable

**IDP** MP series

1-10V/0-10V/DALI

**IDP** SC series

Other brand is available upon request

\*Use IDP multi-power LED Driver can trim down the output power according to actual application.

### Light Distribution For 3000K

spot 24°

medium 36°

h(m)	E(lx)	ø(m)	h(m)	E(lx)	ø(m)
1	1532	ø0.27	1	880.8	ø0.38
2	383.1	ø0.54	2	220.2	ø0.76
3	170.2	ø0.81	3	97.92	ø1.14
4	95.76	ø1.09	4	55.08	ø1.53
5	61.32	ø1.36	5	34.84	ø1.91

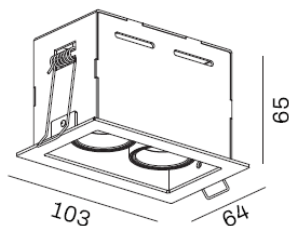

Cutout: 94x55mm

5-25mm

**\*\*Accessories (optional): Honeycomb louvre**

**\*\*The specification is subject to change without notes.\*\***

## SQUARE/SPOT LIGHT/MINI/BOX/TRIPLE HEADS/TILTABLE

**Model: SR-DL3446**



### Feature:

- TRIPLE heads square grilled downlight
- Interchangeable baffle
- Compact design

### Technical data:

- Light source COB or others
- LED Power (max) 5.4W x 3 (150mA x 2 , 36V)
- System Power (ref.) 7W x 3 (ref. only depends on the ECG)
- Lumen flux (typ.) 350lm x 3
- Colour temperature 2700K, 3000K, 4000K
- Colour rendering index Ra $\geq$ 90
- MacAdam Step 3
- Beam Angle 15D, 24D, 36D PMMA Lens
- Tilttable Yes
- Ingress protection IP21
- Operation temperature 0-40C
- Protection Class III
- LED Life time 50,000h L70B10
- Finishing White/Black
- Baffle Finishing Plain White/Plain Black/Brushed Brass
- Construction Aluminum
- Installation Ceiling Recessed, spring type
- Dimension 142x64mmx65mm(H)/Cutout 133x55mm
- LED Driver Remote
- Trimless version No

### Electronic control gear

NON-DIM/Dimmable **IDP** MP series

1-10V/0-10V/DALI **IDP** SC series

Other brand is available upon request

\*Use IDP multi-power LED Driver can trim down the output power according to actual application.

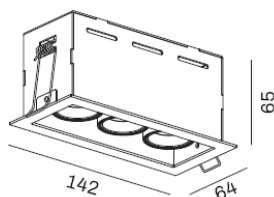

 Cutout: 133x55mm

 5-25mm

#### Light Distribution For 3000K

spot 24°			medium 36°		
h(m)	E(lx)	ø(m)	h(m)	E(lx)	ø(m)
1	2554	ø0.45	1	1468	ø0.64
2	638.6	ø0.91	2	367.1	ø1.27
3	283.8	ø1.36	3	163.2	ø1.91
4	159.6	ø1.82	4	91.80	ø2.55
5	102.2	ø2.27	5	58.70	ø3.19

**\*\*Accessories (optional): Honeycomb louvre**

**\*\*The specification is subject to change without notes.\*\***

## SQUARE/SPOT LIGHT/MEDIUM/BOX/SINGLE/TILTABLE

**Model: SR-DL3232**

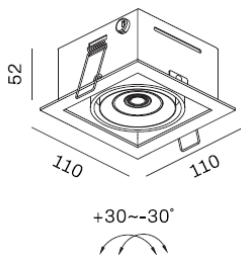

Cutout: 100x100mm

5-25mm

### Feature:

- Single head square grilled downlight
- Gimble tilt 30 degree
- Compact design with IP54 rating

### Technical data:

- Light source COB or others
- LED Power (max) 9W (250mA, 36V)
- System Power (ref.) 11W (ref. only depends on the ECG)
- Lumen flux (typ.) 650lm
- Colour temperature 2700K, 3000K, 4000K
- Colour rendering index Ra $\geq$ 90
- MacAdam Step 3
- Beam Angle 24D, 36D, 45D PMMA Lens
- Tilttable Yes
- Ingress protection IP54
- Operation temperature 0-40C
- Protection Class III
- LED Life time 50,000h L70B10
- Finishing White/Black
- Construction Aluminum
- Installation Ceiling Recessed, spring type
- Dimension 110x110mmx52mm(H)/Cutout 100x100mm
- LED Driver Remote
- Trimless version Yes, please contact us in detail

### Electronic control gear

NON-DIM/Dimmable

MP series

1-10V/0-10V/DALI

SC series

Other brand is available upon request

\*Use IDP multi-power LED Driver can trim down the output power according to actual application.

Light Distribution For 2700K  
wide 44.1°



h(m)	E(lx)	ø(m)
1	1235	ø0.81
2	308.7	ø1.62
3	137.2	ø2.43
4	77.17	ø3.24
5	49.39	ø4.05

**\*\*The specification is subject to change without notes.\*\***

## SQUARE/SPOT LIGHT/MEDIUM/BOX/TWIN HEADS/TILTABLE

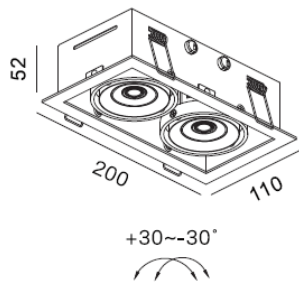
**Model: SR-DL3233**



 Cutout: 190x100mm  
 5-25mm

### Feature:

- TWIN head square grilled downlight
- Gimble tilt 30 degree
- Compact design with IP54

### Technical data:

- Light source COB or others
- LED Power (max) 9W x 2 (250mA x 2, 36V)
- System Power (ref.) 11W x 2 (ref. only depends on the ECG)
- Lumen flux (typ.) 1200lm
- Colour temperature 2700K, 3000K, 4000K
- Colour rendering index Ra $\geq$ 90
- MacAdam Step 3
- Beam Angle 24D, 36D, 45D PMMA Lens
- Tilttable Yes
- Ingress protection IP54
- Operation temperature 0-40C
- Protection Class III
- LED Life time 50,000h L70B10
- Finishing White/Black
- Construction Aluminum
- Installation Ceiling Recessed, spring type
- Dimension 200x110mmx52mm(H)/Cutout 190x110mm
- LED Driver Remote
- Trimless version Yes, Please contact us in detail

### Electronic control gear

NON-DIM/Dimmable

 MP series

1-10V/0-10V/DALI

 SC series

Other brand is available upon request

Light Distribution For 2700K  
wide 43°

h(m)	E(lx)	ø(m)
1	2517	ø0.78
2	629.2	ø1.57
3	279.6	ø2.36
4	157.3	ø3.15
5	100.7	ø3.94

**\*\*The specification is subject to change without notes.\*\***

## SQUARE/SPOT LIGHT/MEDIUM/BOX/TRIPLE HEADS/TILTABLE

**Model: SR-DL3350**

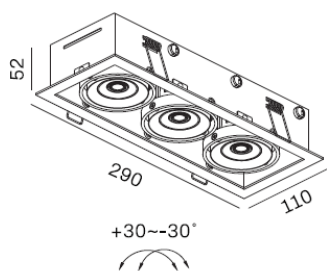

Cutout: 280x100mm

5-25mm

### Feature:

- TRIPLE head square grilled downlight
- Gimble tilt 30 degree
- Compact design with IP54

### Technical data:

- Light source COB or others
- LED Power (max) 9W x 3 (250mA x 2, 36V)
- System Power (ref.) 11W x 3 (ref. only depends on the ECG)
- Lumen flux (typ.) 1200lm
- Colour temperature 2700K, 3000K, 4000K
- Colour rendering index  $Ra \geq 90$
- MacAdam Step 3
- Beam Angle 24D, 36D, 45D PMMA Lens
- Tilttable Yes
- Ingress protection IP54
- Operation temperature 0-40C
- Protection Class III
- LED Life time 50,000h L70B10
- Finishing White/Black
- Construction Aluminum
- Installation Ceiling Recessed, spring type
- Dimension 280x110mmx52mm(H)/Cutout 280x100mm
- LED Driver Remote
- Trimless version No

### Electronic control gear

NON-DIM/Dimmable

IDP MP series

1-10V/0-10V/DALI

IDP SC series

Other brand is available upon request

\*Use IDP multi-power LED Driver can trim down the output power according to actual application.

### Light Distribution For 3000K

spot 24°			medium 36°		
h(m)	E(lx)	ø(m)	h(m)	E(lx)	ø(m)
1	7878	ø0.46	1	4358	ø0.64
2	1969	ø0.91	2	1089	ø1.29
3	875.3	ø1.36	3	484.2	ø1.93
4	492.4	ø1.82	4	272.4	ø2.58
5	315.1	ø2.27	5	174.3	ø3.22

\*\*The specification is subject to change without notes.\*\*

## SQUARE/SPOT LIGHT/JUMBO/BOX/SINGLE/TILTABLE

**Model: SR-DL3360**

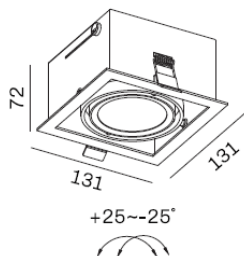

 Cutout: 122x122mm

 5-25mm

### Feature:

- Single head square grilled downlight
- Gimble tilt 25 degree
- Reflector type

### Technical data:

- |                          |   |
|--------------------------|---|
| ▪ Light source           | COB or others                                     |
| ▪ LED Power (max)        | 18W (500mA, 36V)                                  |
| ▪ System Power (ref.)    | 21W <small>(ref. only depends on the ECG)</small> |
| ▪ Lumen flux (typ.)      | 1850lm  |
| ▪ Colour temperature     | 2700K, 3000K, 4000K                               |
| ▪ Colour rendering index | Ra $\geq$ 90                                      |
| ▪ MacAdam Step           | 3   |
| ▪ Beam Angle             | 15D, 24D, 36D Reflector                           |
| ▪ Tilttable              | Yes   |
| ▪ Ingress protection     | IP21  |
| ▪ Operation temperature  | 0-40C   |
| ▪ Protection Class       | III   |
| ▪ LED Life time          | 50,000h L70B10                                    |
| ▪ Finishing              | White/Black                                       |
| ▪ Construction           | Aluminum  |
| ▪ Installation           | Ceiling Recessed, spring type                     |
| ▪ Dimension              | 131x131mmx72mm(H)/Cutout<br>122x122mm             |
| ▪ LED Driver             | Remote  |
| ▪ Trimless version       | No  |

### Electronic control gear

NON-DIM/Dimmable

 MP series

1-10V/0-10V/DALI

 SC series

Other brand is available upon request

\*Use IDP multi-power LED Driver can trim down the output power according to actual application.

**\*\*Accessories (optional): Honeycomb, diffuser\*\***

**\*\*The specification is subject to change without note.\*\***



## SQUARE/SPOT LIGHT/JUMBO/BOX/TWIN HEADS/TILTABLE

**Model: SR-DL3259**

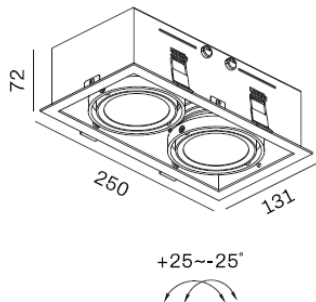

 Cutout: 240x122mm

 5-25mm

### Feature:

- TWIN heads square grilled downlight
- Gimble tilt 25 degree
- Reflector type

### Technical data:

- |                          |  |
|--------------------------|--|
| ▪ Light source           | COB or others                          |
| ▪ LED Power (max)        | 18W x 2 (500mA x 2, 36V)               |
| ▪ System Power (ref.)    | 21W x 2 (ref. only depends on the ECG) |
| ▪ Lumen flux (typ.)      | 3700lm                                 |
| ▪ Colour temperature     | 2700K, 3000K, 4000K                    |
| ▪ Colour rendering index | Ra≥90                                  |
| ▪ MacAdam Step           | 3                                      |
| ▪ Beam Angle             | 15D, 24D, 36D Reflector                |
| ▪ Tilttable              | Yes                                    |
| ▪ Ingress protection     | IP21                                   |
| ▪ Operation temperature  | 0-40C                                  |
| ▪ Protection Class       | III                                    |
| ▪ LED Life time          | 50,000h L70B10                         |
| ▪ Finishing              | White/Black                            |
| ▪ Construction           | Aluminum                               |
| ▪ Installation           | Ceiling Recessed, spring type          |
| ▪ Dimension              | 250x131mmx72mm(H)/Cutout<br>240x122mm  |
| ▪ LED Driver             | Remote                                 |
| ▪ Trimless version       | No                                     |

### Electronic control gear

NON-DIM/Dimmable

 MP series

1-10V/0-10V/DALI

 SC series

Other brand is available upon request

\*Use IDP multi-power LED Driver can trim down the output power according to actual application.

**\*\*Accessories (optional): Honeycomb, diffuser\*\***

**\*\*The specification is subject to change without note.\*\***

## SQUARE/SPOT LIGHT/JUMBO/BOX/TRIPLE HEADS/TILTABLE

**Model: SR-DL3643**

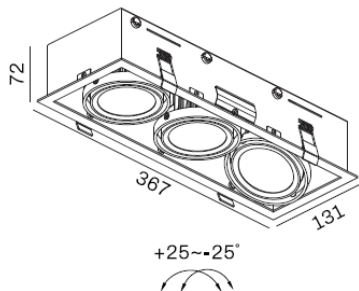

Cutout: 356x122mm

5-25mm

### Feature:

- TRIPLE heads square grilled downlight
- Gimble tilt 25 degree
- Reflector type

### Technical data:

- |                          |  |
|--------------------------|--|
| ▪ Light source           | COB or others                          |
| ▪ LED Power (max)        | 18W x 3 (500mA x 3, 36V)               |
| ▪ System Power (ref.)    | 21W x 3 (ref. only depends on the ECG) |
| ▪ Lumen flux (typ.)      | 3700lm                                 |
| ▪ Colour temperature     | 2700K, 3000K, 4000K                    |
| ▪ Colour rendering index | Ra $\geq$ 90                           |
| ▪ MacAdam Step           | 3                                      |
| ▪ Beam Angle             | 15D, 24D, 36D Reflector                |
| ▪ Tilttable              | Yes                                    |
| ▪ Ingress protection     | IP21                                   |
| ▪ Operation temperature  | 0-40C                                  |
| ▪ Protection Class       | III                                    |
| ▪ LED Life time          | 50,000h L70B10                         |
| ▪ Finishing              | White/Black                            |
| ▪ Construction           | Aluminum                               |
| ▪ Installation           | Ceiling Recessed, spring type          |
| ▪ Dimension              | 367x131mmx72mm(H)/Cutout<br>356x122mm  |
| ▪ LED Driver             | Remote                                 |
| ▪ Trimless veriosn       | No                                     |

### Electronic control gear

NON-DIM/Dimmable

**IDP** MP series

1-10V/0-10V/DALI

**IDP** SC series

Other brand is available upon request

\*Use IDP multi-power LED Driver can trim down the output power according to actual application.

**\*\*Accessories (optional): Honeycomb, diffuser\*\***

**\*\*The specification is subject to change without note.\*\***